

REV.	ECN NO OR DESCRIPTION	REVISED	DATE
A	PROPOSE ONLY	ALLEN	06/14/06

※ Specifications

1. Voltage Rating : 30V_{AC}/DC
2. Current Rating : 0.3A/Pin
3. Operating temperature : -30℃~+80℃
4. Mating Force : 1.5Kgf Max
5. Un-Mating Force : 0.4~1.5Kgf
4. Durability : 5,000 cycles

※ NOTE

1. PLATING
- 1) CONTACT
- Contact Area : Au 0.2 μ m over Ni 1.0~5.0 μ m
- Lead Area : Au 0.05 μ m over Ni 0.2~3.0 μ m
- 2) METAL COVER : Ni 1.0~5.0 μ m

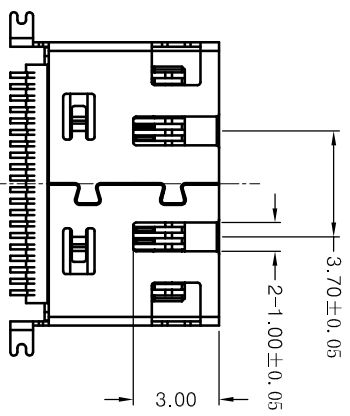
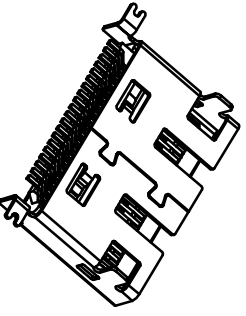
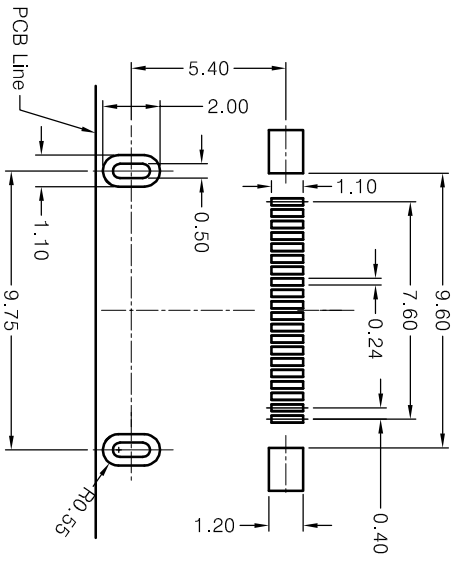
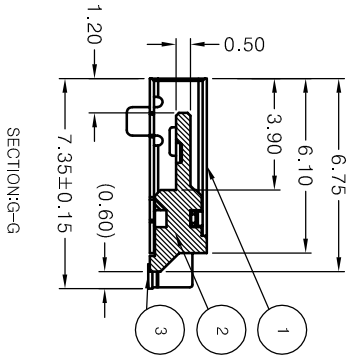
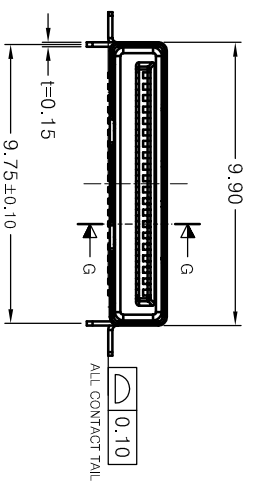
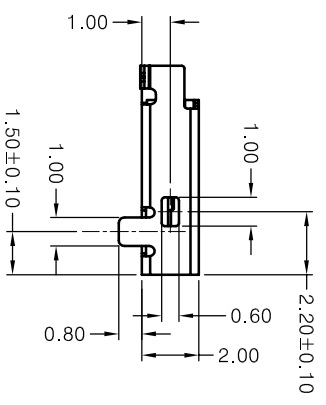
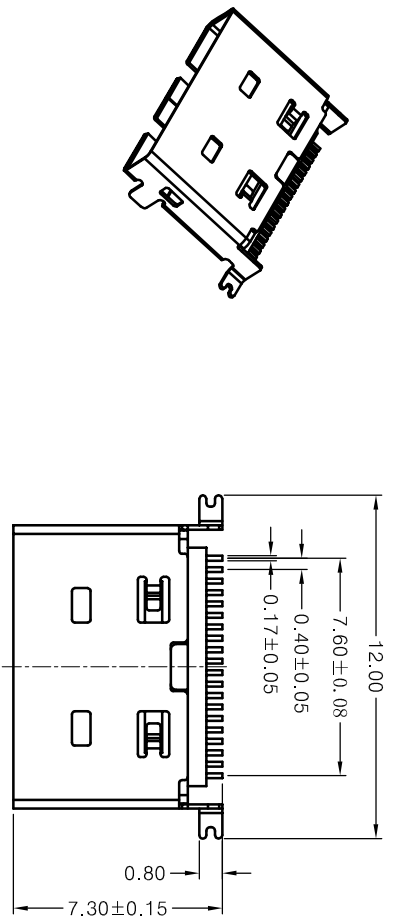

NO.	DESCRIPTION	QTY	MATERIAL	NOTE
3	CONTACT	20	COPPER ALLOY	GOLDFLATED
2	HOUSING	1	THERMOPLASTICS	COLOR:BLACK
1	SHELL	1	STAINLESS STEEL	TIN PLATED

UNLESS OTHERWISE SPECIFIED TOLERANCES

DECIMALS:	ANGLES:
X : ±0.5	X : ±2°
X.X : ±0.20	X.X : ±1°
X.XX : ±0.10	

TITLE	EAR/MIC 20PIN FEMALE (LG Rev.)
DWN	ALLEN
CHKD	KEVIN
APVD	ERIC.W
PART NO.	9202-02015-01R
SCALE:	1:1
UNIT:	mm
SHEET:	1 OF 1
REV:	A

深圳市精密兴业有限公司
SHENZHEN KRCOONN TECHNOLOGY CO., LTD

CUSTOMER COPY