

REV.	ECN NO OR DESCRIPTION	REVISED	DATE
A	PROPOSE ONLY	ALLEN	08/14/08

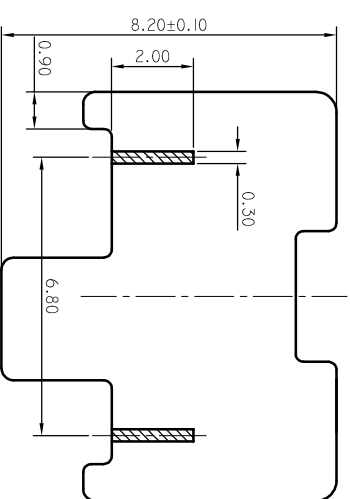

PCB LAYOUT(TOP VIEW)  
(TOLERANCE:±0.05)

PCB LAYOUT(BACK VIEW)  
(TOLERANCE:±0.05)

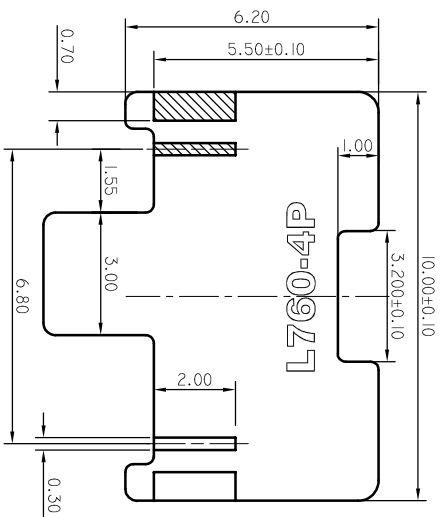
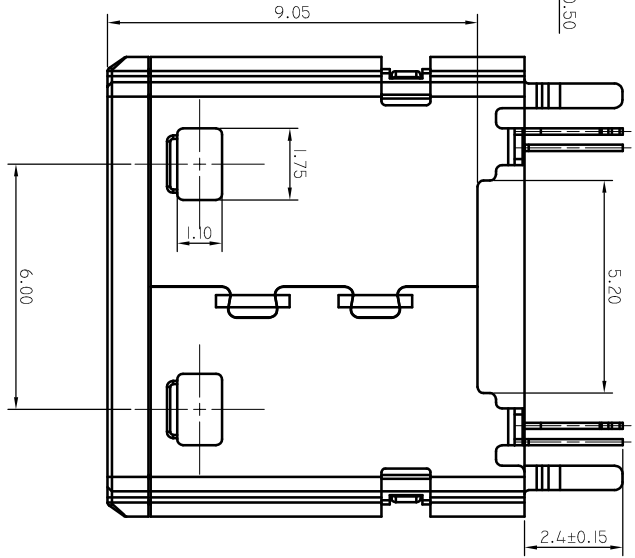
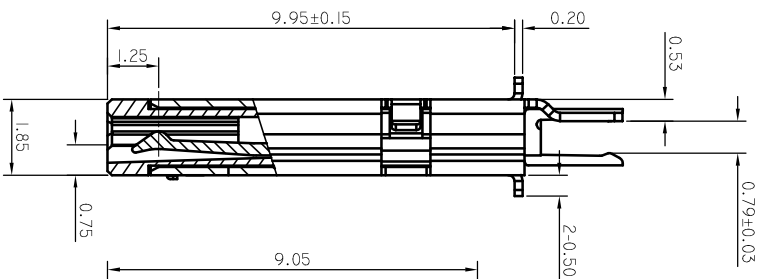
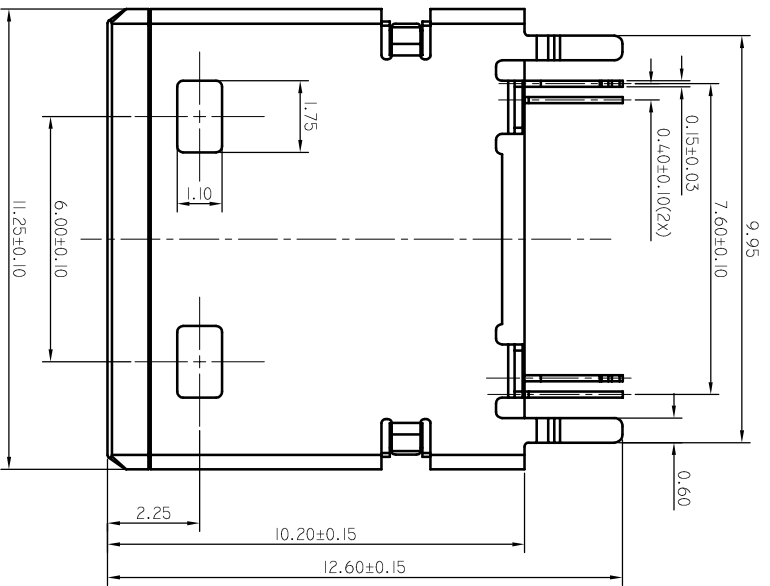
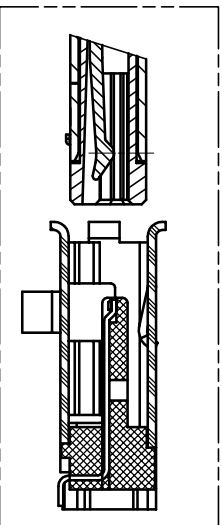
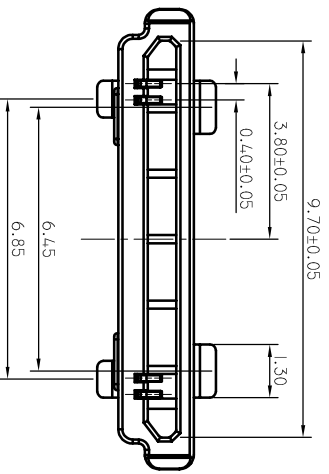

SPECIFICATIONS

- VOLTAGE RATING : .50V/DC
- CURRENT RATING : 0.3A/PIN
- OPERATING TEMPERATURE : -30~+80
- MATING FORCE : 1.5KGf MAX
- UNMATING FORCE : 0.4~1.5KGf
- DURABILITY : 5,000 CYCLES

NOTE

- PLATING
  - 1) CONTACT - CONTACT AREA : AU 15u"
  - 2) METAL COVER : TIN 100u"
- LEAD AREA : AU GOLD FLASH

3	CONTACT	20	PHOSPHOR BRONZE	CONTACT: GOLD FLASH
2	HOUSING	1	PA 9T	COL:OR:BLACK
1	SHELL	1	STAINLESS	NI:50U" TIN:100U" PLATING
NO.	DESCRIPTION	QTY	MATERIAL	NOTE



深圳市睿兴业科技有限公司  
SHENZHEN KRCNN TECHNOLOGY CO., LTD

TITLE: SAMSUNG 20PIN SYS:1/O CONNECTOR ASSEM.

DWN ALLEN PART NO: 9102-02015-05R

CHVD KEVIN SCALE:1:1 UNIT: MM

APVD ERIC.W SIZE: A3 SHEET: OF 1 REV: A

CUSTOMER COPY