

1

2

3

4

5

6

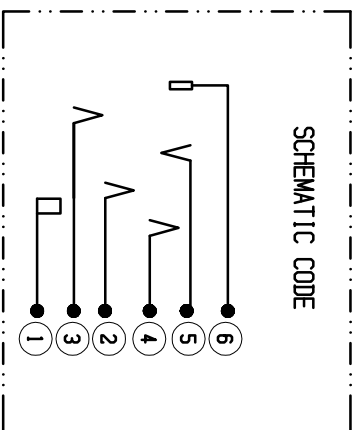
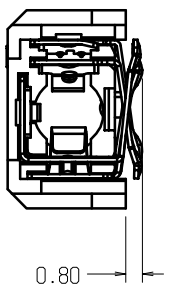
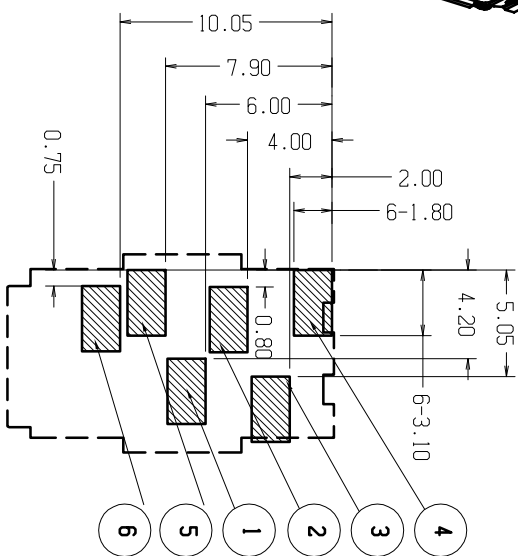
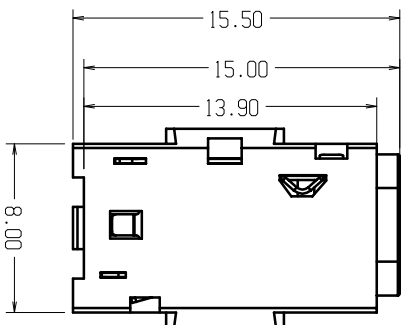
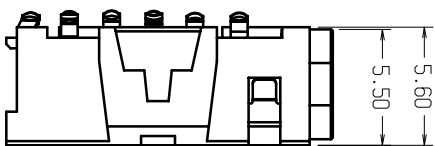
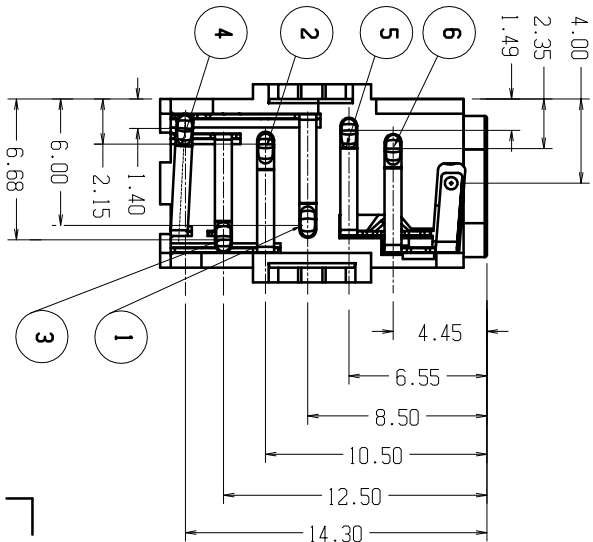
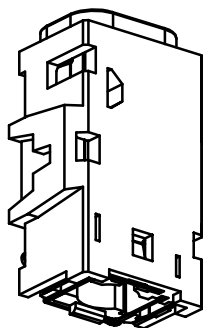
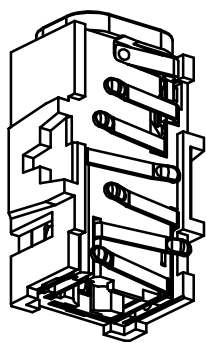
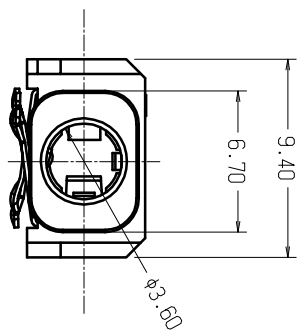

REV.	ECN NO OR DESCRIPTION	REVISED	DATE
A	PROPOSE ONLY		

RECOMMENDED PC BOARD LAYOUT
TOLERANCE, ± 0.05 (TOP VIEW)

2	TERMINAL	6	COPPER ALLOY	CONTACTIVE Au OVER ALL.
1	HOUSING	1	THERMOPLASTIC	UL 94V-0
NO.	DESCRIPTION	QTY	MATERIAL	NOTE
UNLESS OTHERWISE SPECIFIED TOLERANCES				
DECIMALS.	ANGLES.			
X .X	± 0.5	X	$\pm 2^\circ$	
X .X	± 0.20	X .X	$\pm 1^\circ$	
X .XX	± 0.10			
 深圳市精睿兴业有限公司 SHENZHEN JINGXING TECHNOLOGY CO., LTD				
TITLE 6PIN EARPHONE JACK FOR NOKIA				
DWN	JohnLe	PART NO.	9102-00615-01R	
CHKD	Kevin.d	SCALE	1:1	UNIT, mm
APVD		SIZE	A4	SHEET, 10F 1
CUSTOMER COPY				